



1001 CABANES

1001 PLAYHUTS

1001 HÜTTEN



NOTICE D'UTILISATION

USER MANUAL

GEBRAUCHSANWEISUNG



FR ATTENTION ! Ne convient pas aux enfants de moins de 36 mois. Petites pièces. Danger de suffocation. Informations à conserver. Ne pas laisser les enfants monter sur la structure. Risque de rupture des pièces et de blessure. Ne pas laisser les enfants introduire leurs doigts dans les trous des connecteurs. Les étapes d'assemblage et de démontage doivent se faire avec l'aide et sous la supervision d'un adulte, qui vérifiera que le montage est satisfaisant et que la structure est stable avec l'utilisation de la cabane par l'enfant. Au moment de recouvrir la structure d'un tissu, l'adulte veillera à ce qu'une ouverture reste présente pour permettre aux enfants de s'extraire facilement de la cabane.

EN WARNING! Not suitable for children under 36 months. Small pieces. Choking hazard. Information to be retained. Do not allow children to climb on the structure. Risk of broken parts and injury. Do not let children insert their fingers into the holes of the connectors. The assembly and disassembly steps must be done with the help and under the supervision of an adult, who will check that the assembly is properly and securely completed and the structure is stable when the child uses the hut. When covering the structure with a fabric, the adult will ensure that an opening remains present to allow children to easily get out of the hut.

DE ACHTUNG! Nicht geeignet für Kinder unter 36 Monaten. Kleinteile. Es besteht Verwechslungsgefahr. Informationen müssen aufbewahrt werden. Lassen Sie Kinder nicht auf das Gestell steigen, da Teile brechen könnten und die Gefahr von Verletzungen besteht. Kinder dürfen ihre Finger nicht in die Löcher der Verbindungselemente stecken. Der Auf- und Abbau sollte mit Hilfe und unter Aufsicht eines Erwachsenen erfolgen, der sicherstellt, dass der Aufbau ordnungsgemäß erfolgt und die Struktur stabil ist, wenn das Kind die Hütte benutzt. Wenn die Struktur mit einem Tuch abgedeckt wird, muss der Erwachsene darauf achten, dass eine Öffnung vorhanden ist, durch die die Kinder leicht aus der Hütte herausklettern können.



LE PRINCIPE

Découvrez le principe **1001 Cabanes** - Kit de construction de cabanes et cachettes d'intérieur - Modulable, créatif, fabriqué en bois et en tissu 100% coton.

Des possibilités infinies !

Le jeu de construction 1001 Cabanes est **entièrement modulaire** et permet d'inventer des structures légères de formes très variées. Votre enfant pourra ainsi **créer sans limite** des espaces en 3 dimensions.

Un jeu qui stimule l'imagination et la créativité

Vos enfants pourront imaginer des **châteaux, igloos, fusées, bateaux, voitures, grottes et autres bases secrètes**... On parie qu'il va s'en raconter, des histoires !

Des matériaux nobles et sûrs

Du **bois brut** issu de **forêts européennes**, et des **tissus 100% cotons certifiés OekoTex**, pour des jouets qui durent toute une vie.

Un jeu pour tous les âges !

Construire des cabanes, c'est vieux comme le monde ! Ce jeu favorise **l'entraide** et le **jeu entre des enfants d'âges différents** : les plus grands seront les architectes et les constructeurs, tandis que les petits s'y abriteront pour inventer leurs histoires.

Bien cachés aux yeux des adultes !

Vous connaissez vos enfants... Quand ils inventent des histoires, ils ne veulent pas être dérangés ! C'est pourquoi nous avons prévu des **toiles de dimensions multiples qui s'adapteront à toutes les créations** pour recouvrir entièrement leur cabane. Aucun risque de laisser fuiter leurs secrets !

CONTENU DE VOTRE BOITE

Le pack 1001 Cabanes existe en différents formats : ci-dessous le contenu de chaque pack.

LE PACK LIBELLULE

- 27 tiges 45cm
- 16 connecteurs en bois
- 1 notice explicative
- 1 sachet de rangement en coton

LE PACK ECUREUIL

- 48 tiges 45cm
- 24 connecteurs en bois
- 1 notice explicative
- 1 sachet de rangement en coton

LE PACK CASTOR

- 73 tiges 45cm
- 38 connecteurs en bois
- 1 notice explicative
- 1 sachet de rangement en coton

LE PACK GRIZZLY

- 102 tiges 45cm
- 53 connecteurs en bois
- 1 notice explicative
- 1 sachet de rangement en coton

Les packs 1001 Cabanes sont-ils combinables ?



OUI ! Tous les packs sont constitués du même type de connecteurs et de tiges, pour multiplier les possibilités à l'infini !

CONSEIL DE RANGEMENT : Conserver dans un endroit sec.



INSTRUCTIONS

Insérez les tiges dans les trous des connecteurs pour les assembler entre eux selon des angles de 90 ou 45 degrés. Ces ensembles vont former des structures légères de forme très variées constituées de carrés ou de triangles.



Les étapes d'assemblage et de démontage doivent se faire avec l'aide et sous la supervision d'un adulte, qui vérifiera que le montage est satisfaisant et que la structure est stable avec l'utilisation de la cabane par l'enfant.

1

Commencez par **construire une base** qui définira la forme de votre construction au sol (carrée, hexagonale, ...). Assurez-vous que la base soit stable et posée sur une surface plane.

2

En partant de cette base, **élevez la structure en hauteur**.

3

Une fois la structure finalisée, **disposez un tissu** de façon à **recouvrir la structure** de manière optimale.

4

Préparez-vous à **des heures et des heures de jeux** !

5

Quand c'est fini, vous pouvez **tout démonter et ranger** dans le sac en coton. Demain vous imaginerez une autre cabane !

L'ASTUCE 1001 CABANES

Le bois est un matériau vivant ! Les conditions de température et d'humidité de votre intérieur peuvent jouer sur la dilatation des pièces. Si par moments, la tenue des tiges dans les connecteurs devient moins bonne, pas de panique ! Il suffit d'**humidifier le trou avec le spray fourni à cet effet, ou de tremper l'extrémité de la tige dans l'eau quelques instants**, puis de l'insérer dans le trou du connecteur. L'adhérence sera instantanément meilleure !



Exemples de modèles réalisés avec le pack 1001 Cabanes Libellule

La grotte

- 16 connecteurs
- 26 tiges

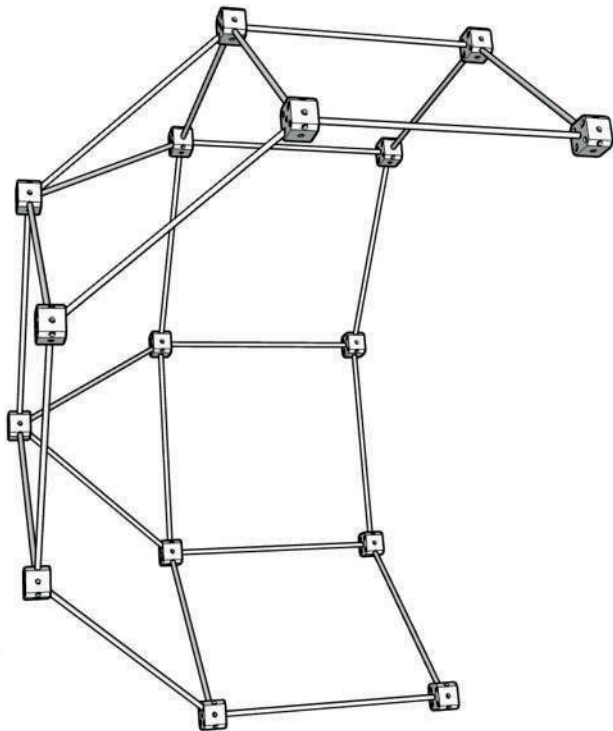

La tente de campeur

- 15 connecteurs
- 22 tiges

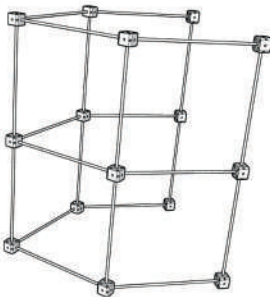

La petite maison

- 14 connecteurs
- 23 tiges

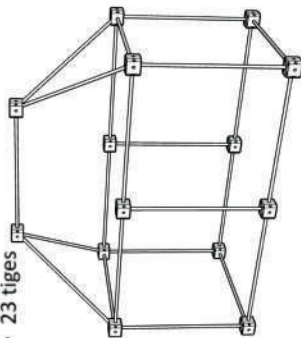

Le château à 1 tour

- 16 connecteurs
- 27 tiges

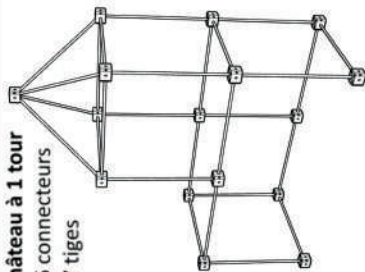

Le bateau

- 15 connecteurs
- 27 tiges

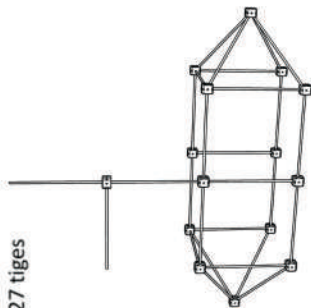



Exemples de modèles réalisés avec le pack 1001 Cabanes Ecureuil

L'igloo

- 24 connecteurs
- 44 tiges

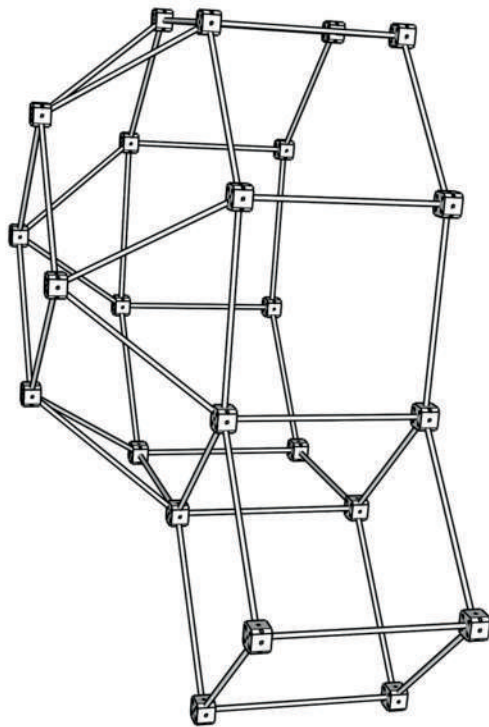

Le château tour centrale

- 23 connecteurs
- 48 tiges

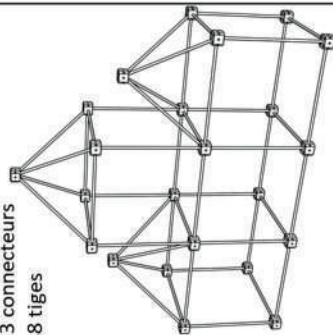

La fusée

- 21 connecteurs
- 40 tiges

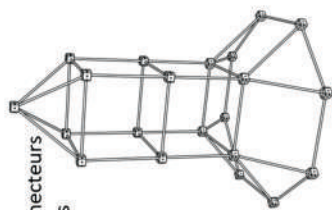

La maison toit pointu

- 24 connecteurs
- 42 tiges

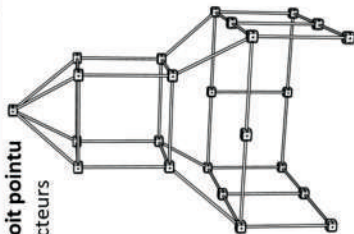

La longère bateau

- 24 connecteurs
- 38 tiges

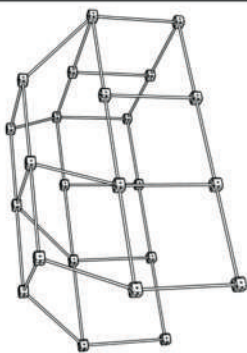



Exemples de modèles réalisés avec le pack 1001 Cabanes Castor

Le grand château à 2 toits

- 38 connecteurs
- 73 tiges

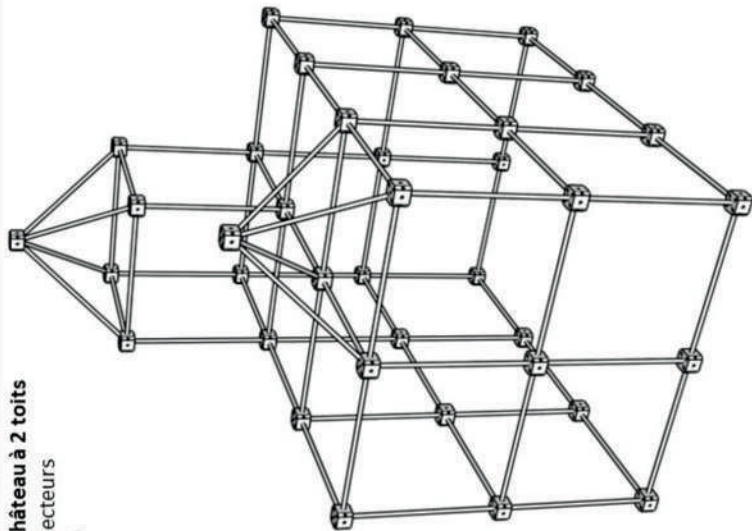

La yourte

- 33 connecteurs
- 52 tiges

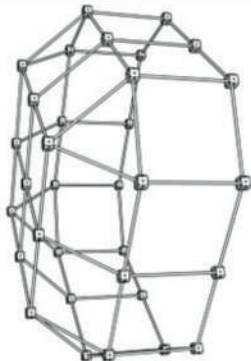

La grande maison au toit plat

- 26 connecteurs
- 44 tiges

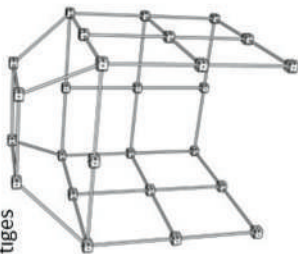

Le château à 2 tours

- 27 connecteurs
- 56 tiges

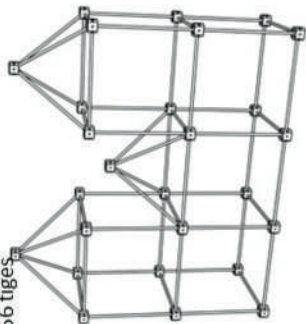

L'igloo et son toit

- 29 connecteurs
- 56 tiges



Exemples de modèles réalisés avec le pack 1001 Cabanes Grizzly



Le château à 4 tours

- 48 connecteurs
- 88 tiges

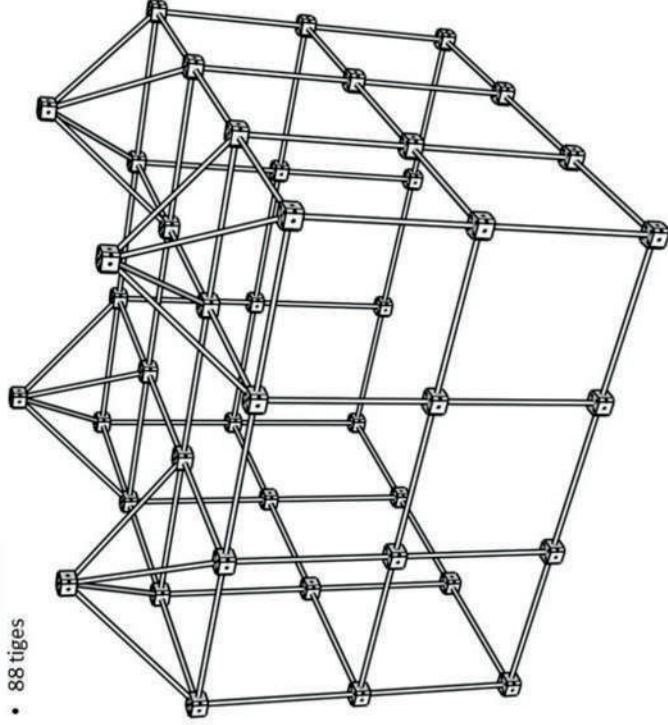

Les cabanes connectées

- 53 connecteurs
- 100 tiges

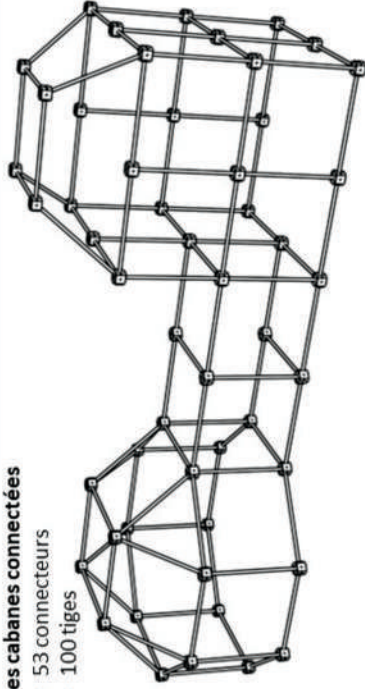

La Villa spacieuse

- 51 connecteurs
- 97 tiges

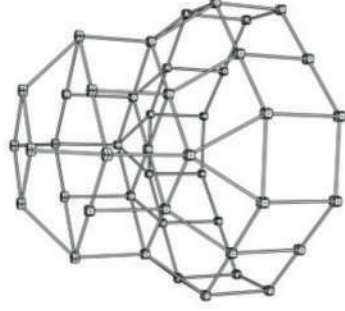

FR

L'AVENTURE NE S'ARRÊTE PAS LÀ



Trouvez des idées de création sur notre site en scannant ce QR Code :



Et partagez vos créations sur les réseaux avec le hashtag **#1001cabanes**.

En cas de problème ou question avec votre produit, n'hésitez pas à nous contacter via le formulaire de contact disponible sur notre site internet www.sarbakane.fr, ou par mail à l'adresse contact@sarbakane.fr.

Suivez-nous sur les réseaux sociaux :



@sarbakane_toys



SarbakaneToysFR



THE PRINCIPLE

Discover the principle of **1001 PlayHuts** - A set for building huts and indoor hideouts - Modular, creative, made of wood and 100% cotton fabric.

Limitless possibilities

The construction set 1001 PlayHuts is **fully modular** and allows children to imagine light structures of many various shapes. They will be plunging into hours of open-ended play to create 3 dimensional hideouts.

A game for all ages

Building huts is as old as the world! This game encourages **mutual help** and **cooperation between children of different ages**: the oldest will be architects and builders, while the little ones will take shelter for role-playing games.

Imagination and creativity stimulation

Your children will imagine and build **castles, igloos, rocketships, boats, cars, caves and others secret bases** ... We can bet role playing and stotyelling will be endless!

Well hidden from the adults sight!

You know your children... When they make up stories, they don't want to be disturbed! This is why we provide **cotton fabric of multiple dimensions** that will **adapt to all creations** to fully conceal their secrets.

Safe and noble materials

Solid untreated wood from **European forests**, **100% cotton fabric OekoTex certified**, for toys that will last a lifetime and be passed down from one generation to another.

SET CONTENT

1001 PlayHuts exists in different sizes: below the content of each set.

DARGONFLY SET



- 27 rods 45cm
- 16 wooden connectors
- 1 user manuel
- 1 cotton storage bag
- 1 water spray

SQUIRREL SET



- 48 rods 45cm
- 24 wooden connectors
- 1 user manuel
- 1 cotton storage bag
- 1 water spray

BEAVER SET



- 73 rods 45cm
- 38 wooden connectors
- 1 user manuel
- 1 cotton storage bag
- 1 water spray

GRIZZLY SET



- 102 rods 45cm
- 53 wooden connectors
- 1 user manuel
- 1 cotton storage bag
- 1 water spray

Are all 1001 PlayHuts sets compatible with each other ?



YES ! The connectors and rods used in all sets are identical, allowing endless possibilities!

STORAGE ADVICE : Keep in a dry area.



INSTRUCTIONS

Place the rods into the connector holes to connect them at either 90 or 45 degree angles. These elements connected together will start forming light structures of various shapes made of squares or triangles.



The assembly and disassembly steps must be done with the help and under supervision of an adult, who will check that the assembly is properly and securely completed and the structure is stable when the child uses the hut.

1

Start assembling the pieces horizontally on the floor in order to define the shape of the hut on the floor (square, octagonal, etc.). Ensure that the base is secure and placed on a level surface.

2

Begin building upwards by inserting rods vertically into the cubes already placed on the ground. Make sure that each level is securely connected before starting building a higher one.

3

Once the structure is completed, you can cover it with a fabric, a cover or a blanket.

4

Get ready for **hours and hours of play and role-playing games!**

5

Once it's over, you can **take everything apart and put it away in the cotton bag**. Tomorrow you will imagine and build another hut!

THE 1001 PLAYHUTS TIP

Wood is a living material! The temperature and humidity conditions of your interior can play on the pieces expansion. If at times the rods don't grip as well as before in the connectors, no worries! Simply **wet the hole with the spray provided for this purpose, or soak the end of the rod in water for a few moments**, then insert it into the hole of the connector. The grip will be instantly better!



Examples of models built with the Dragonfly set

The cave

- 16 connectors
- 26 rods

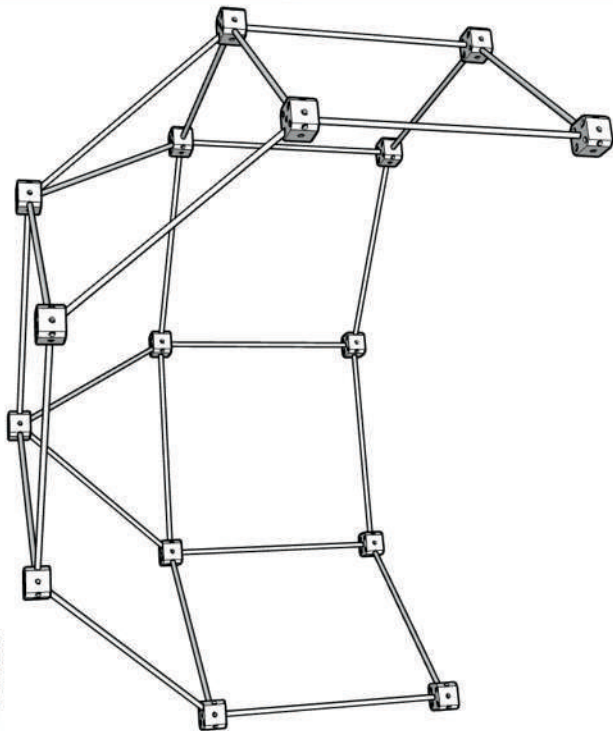

The camper's tent

- 15 connectors
- 22 rods

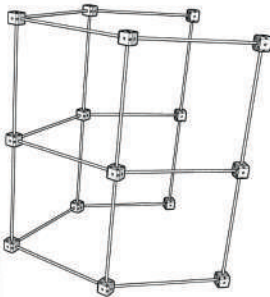

The small house

- 14 connectors
- 23 rods

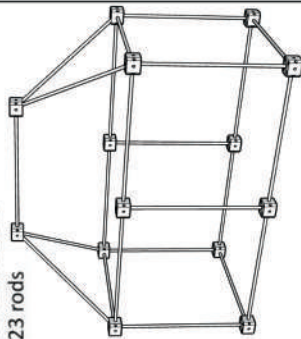

The single tower castle

- 14 connectors
- 27 rods

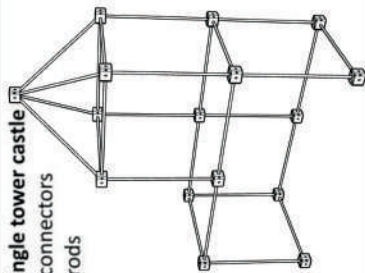

The boat

- 15 connectors
- 27 rods

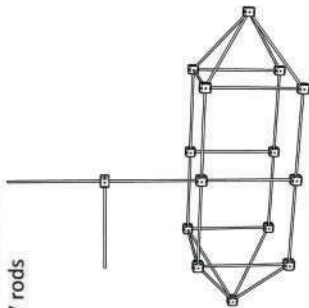



Examples of models built with the Squirrel set

The igloo

- 24 connectors
- 44 rods

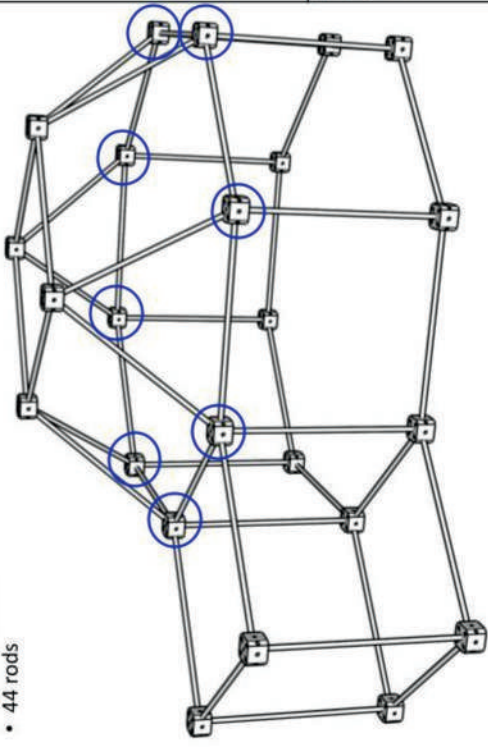

ATTENTION : when building the igloo and similar shapes of structures, the direction of the connectors circled in blue matters. At this level, a rod should always be pointing similar faces of the connector.

The central tower castle

- 23 connectors
- 48 rods

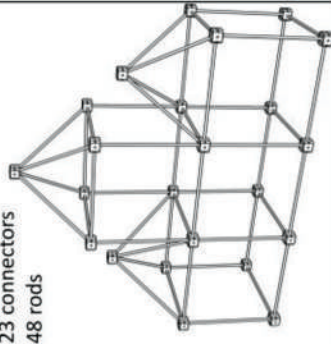

The rocketship

- 21 connectors
- 40 rods

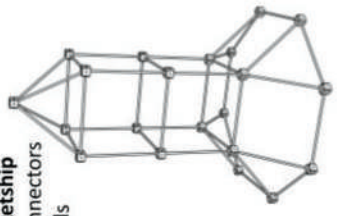

The house with pointed roof

- 24 connectors
- 42 rods

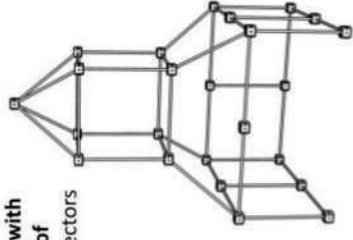

The long house

- 24 connectors
- 38 rods

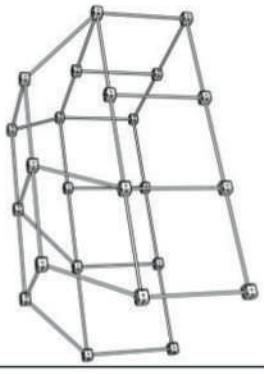



Examples of models built with the Beaver set

The large castle with 2 roofs

- 38 connectors
- 73 rods

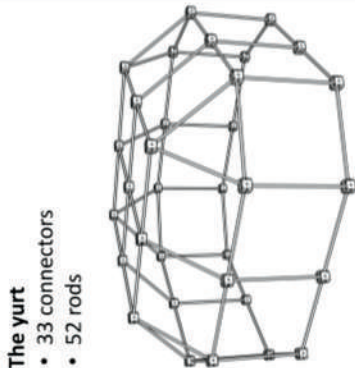

The yurt

- 33 connectors
- 52 rods

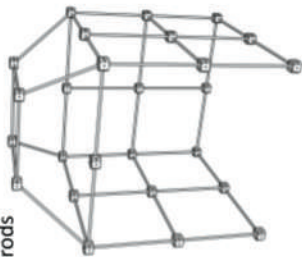

The flat-roofed large house

- 26 connectors
- 44 rods

The 3-towers castle

- 27 connectors
- 56 rods

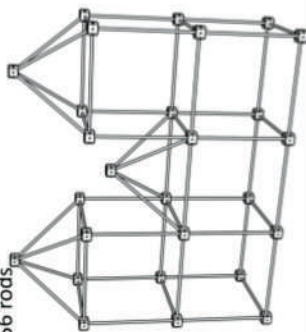

The igloo with a roof

- 29 connectors
- 56 rods

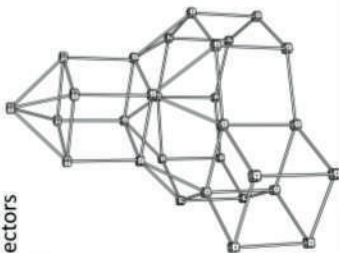

Examples of models built with the Grizzly set

The 4-towers castle

- 48 connectors
- 88 rods

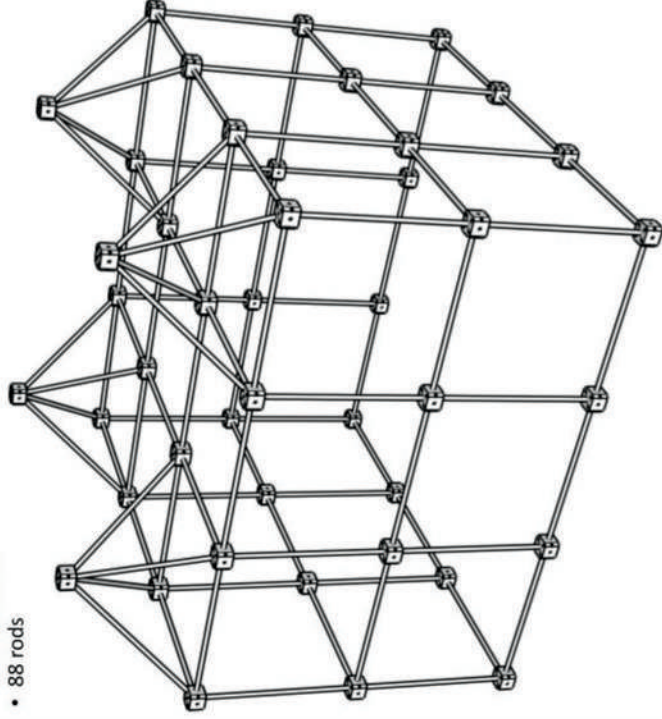

The twin huts

- 53 connectors
- 100 rods

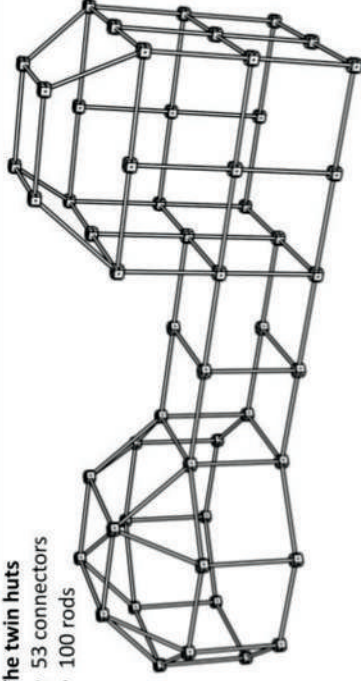

The large country house

- 51 connectors
- 97 rods

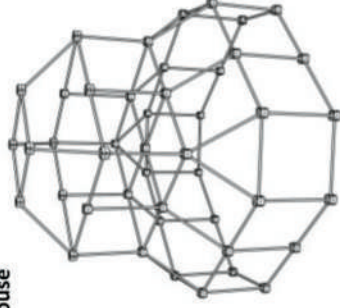

EN



THE ADVENTURE DOES NOT END HERE



Find creations ideas on our website by scanning this QR Code:



Share your creations on social media with the hashtag **#1001playhut**.

If you have a problem or need help with our product, please contact us via the contact form available on our website www.sarbakane.com, or by email at contact@sarbakane.fr

Follow us on social media :



@sarbakane_toys



SarbakaneToysFR



DAS PRINZIP

Entdecke das Prinzip **1001 Hütten** - Bausatz für Hütten und Verstecke für Innenräume - Modular, kreativ, aus Holz und Textilien aus 100% Baumwolle hergestellt.

Unendliche Möglichkeiten!

Der Baukasten 1001 Hütten ist **vollständig modular** aufgebaut und ermöglicht es, leichte Strukturen in den unterschiedlichsten Formen zu erfinden. So kann Ihr Kind **grenzenlos dreidimensionale Räume erschaffen**.

Für jedes Alter geeignet!

Hütten bauen ist so alt wie die Menschheit! Dieses Spiel fördert **gegenseitiges Helfen** und **Spielen mit Kindern unterschiedlichen Alters**: Die Größeren sind die Architekten und Baumeister, während die Kleineren darin Schutz suchen und Geschichten erfinden.

Ein Spiel, das die Vorstellungskraft und Kreativität anregt

Ihre Kinder können sich **Schlösser, Iglus, Raketen, Boote, Autos, Höhlen und andere Geheimverstecke** ausdenken... Wetten, dass Ihre Kinder viele Geschichten erzählen werden?

Vor Erwachsenen Augen gut versteckt!

Sie kennen doch Kinder ... Bei der Erfindung von Geschichten will man nicht gestört werden! Deshalb haben wir **Leinwände in verschiedenen Größen vorgesehen, die sich an alle Kreationen anpassen** und die Hütte vollständig abdecken. Kein Risiko, dass hier Geheimnisse herauskommen!

Edle und sichere Materialien

Unbehandeltes Holz aus europäischen Wäldern und **Textilien aus 100% Baumwolle mit ÖkoTex-Zertifikat** für Spielzeuge, die ein Leben lang halten.



INHALT DER PACKUNG



Das 1001 Hütten-Paket gibt es in verschiedenen Größen: Unten sehen Sie den Inhalt des jeweiligen Pakets.

LIBELLE-PAKET

- 27 Stäbe - Länge - 45 cm
- 16 Würfel
- 1 Inspirationsbroschüre
- 1 Baumwoll-Aufbewahrungsbeutel



EICHHÖRNCHEN-PAKET

- 48 Stäbe - Länge - 45 cm
- 24 Würfel
- 1 Inspirationsbroschüre
- 1 Baumwoll-Aufbewahrungsbeutel



BIBER-PAKET

- 73 Stäbe - Länge - 45 cm
- 38 Würfel
- 1 Inspirationsbroschüre
- 1 Baumwoll-Aufbewahrungsbeutel



GRIZZLY-PAKET

- 102 Stäbe - Länge - 45 cm
- 53 Würfel
- 1 Inspirationsbroschüre
- 1 Baumwoll-Aufbewahrungsbeutel



**Sind die 1001
Hütten-Pakete
kombinierbar?**



JA! Alle Packs bestehen aus demselben Typ von Verbindungsstücken und Stäben, um die Möglichkeiten endlos zu vervielfältigen!

AUFBEWAHRUNGSTIPP: An einem trockenen Ort aufbewahren.



ANLEITUNG

Stecken Sie die Stäbe in die Löcher der Verbindungselemente, um sie in Winkeln von 90 oder 45 Grad miteinander zu verbinden. Diese Sätze bilden leichte Strukturen in verschiedenen Formen, aus Quadraten oder Dreiecken bestehend.



Die Schritte des Auf- und Abbaus sollten mit Hilfe und unter Aufsicht eines Erwachsenen erfolgen. Es muss sichergestellt werden, dass der Aufbau erfolgreich gelingt und die Struktur bei der Nutzung der Hütte durch das Kind stabil ist.

1

Beginnen Sie mit dem Bau eines Fundamentes, das die Form der Bodenkonstruktion festlegt (quadratisch, sechseckig, ...). Achten Sie darauf, dass das Fundament stabil ist und auf einer ebenen Fläche steht.

2

Ausgehend von dieser Basis bauen Sie die Struktur in die Höhe.

3

Sobald die Struktur vollständig aufgebaut wurde, positionieren Sie einen Stoff so, dass er die Struktur optimal bedeckt.

4

Bereiten Sie sich auf stundenlangen Spielspaß vor!

5

Wenn es fertig ist, können Sie alles auseinandernehmen und in der Baumwolltasche verstauen. Morgen wird Ihnen eine andere Hütte einfallen!

DER 1001-HÜTTEN-TIPP

Holz ist ein lebendiges Material! Die Temperatur- und Feuchtigkeitsbedingungen in Ihrem Zuhause können sich auf die Ausdehnung der Teile auswirken. Wenn die Stäbe in den Verbindungsstücken zeitweise nicht mehr so gut halten, ist das kein Grund zur Sorge! Es genügt, das Loch mit dem dafür vorgesehenen Spray zu befeuchten oder das Stangenende kurz in Wasser zu tauchen und es anschließend in das Loch des Verbindungselements zu stecken. Die Haftung wird sofort wieder besser!



Beispielhafte Vorlagen, die mit dem Libellen-Paket erstellt wurden

Die Höhle

- 16 Würfel
- 26 Stäbe

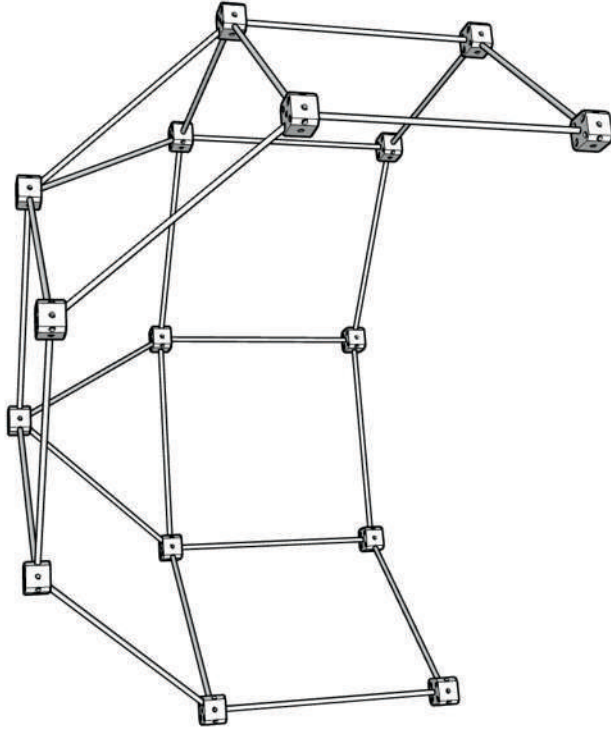

Das Camperzelt

- 15 Würfel
- 22 Stäbe

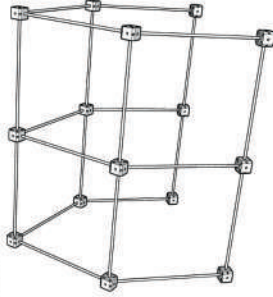

Das kleine Haus

- 14 Würfel
- 23 Stäbe

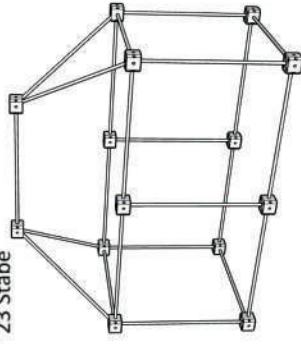

Das Schloss mit 1 Turm

- 16 Würfel
- 27 Stäbe

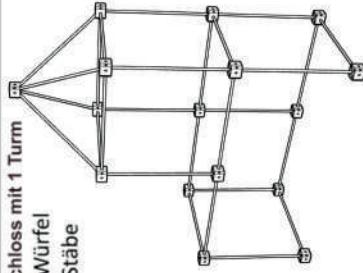

Das Boot

- 15 Würfel
- 27 Stäbe

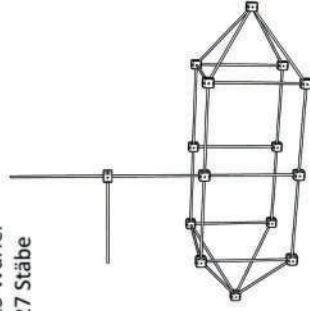



Beispielhafte Vorlagen, die mit dem Eichhörnchen-Paket erstellt wurden

Das Igloo
• 24 Würfel
• 44 Stäbe

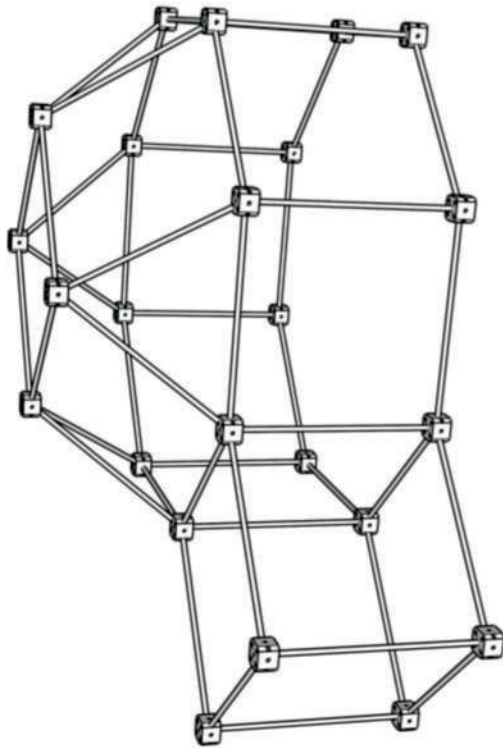

**Das Schloss mit
zentralem Turm**
• 23 Würfel
• 48 Stäbe

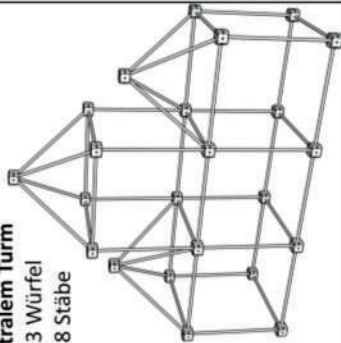

Die Rakete
• 21 Würfel
• 40 Stäbe

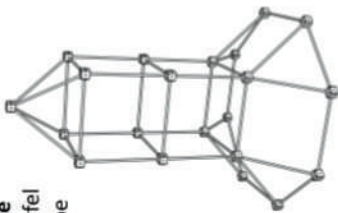

**Das Haus mit
spitzem
Dach**
• 20 Würfel
• 33 Stäbe

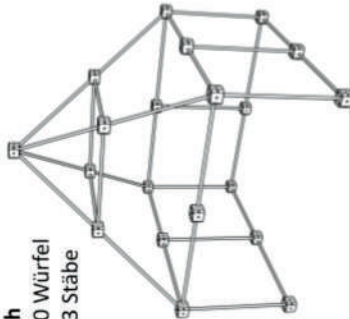

Das Langhaus
• 15 Würfel
• 31 Stäbe

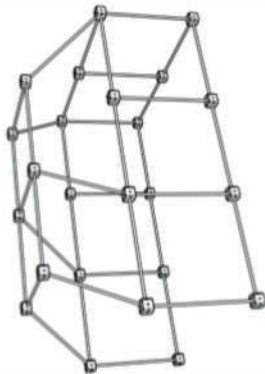



Beispielhafte Vorlagen, die mit dem Biber-Paket erstellt wurden

Das große Schloss mit zwei Dächern

- 38 Würfel
- 73 Stäbe

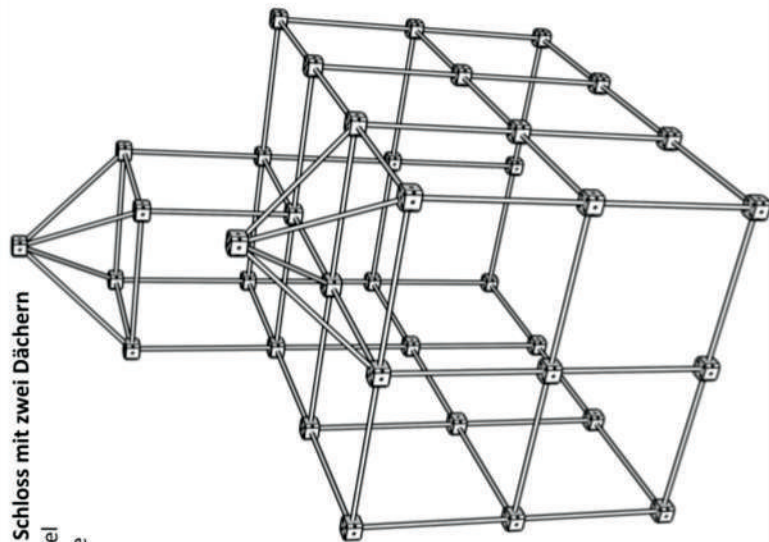

Die Jurte

- 33 Würfel
- 52 Stäbe

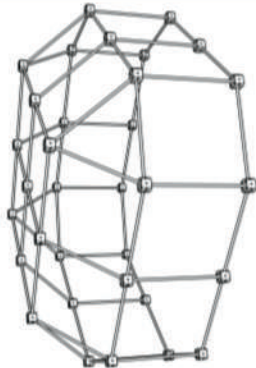

Das große Haus mit Flachdach

- 26 Würfel
- 44 Stäbe

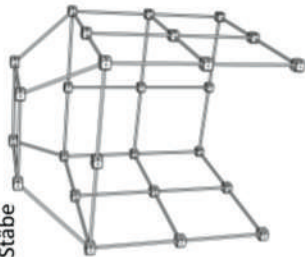

Das Schloss mit 2 Türmen

- 27 Würfel
- 56 Stäbe

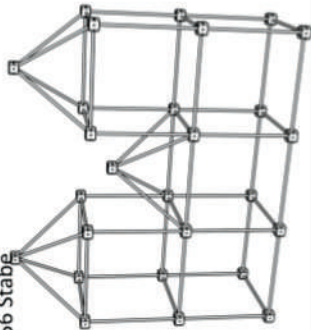

Das Iglu mit Dach

- 29 Würfel
- 56 Stäbe

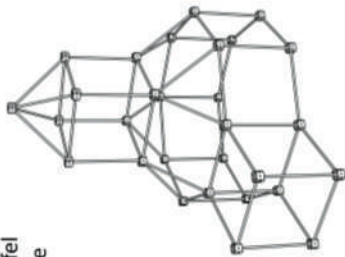



Beispielhafte Vorlagen, die mit dem Grizzly-Paket erstellt wurden

Das Schloss mit 4 Türmen

- 48 Würfel
- 88 Stäbe

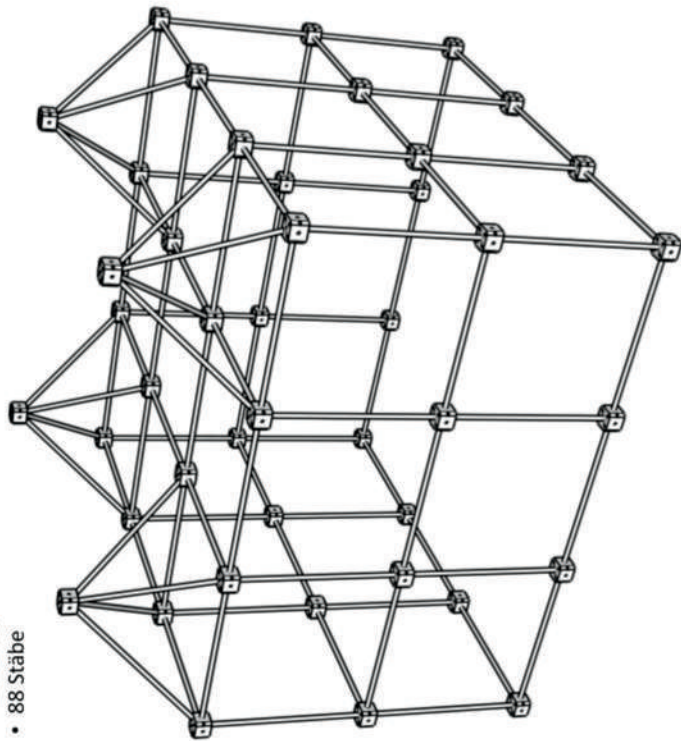

Die Zwillingshütten

- 53 Würfel
- 100 Stäbe

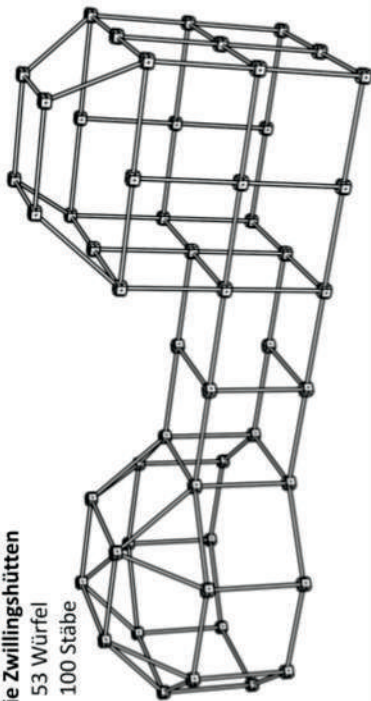

Die geräumige Villa

- 51 Würfel
- 97 Stäbe

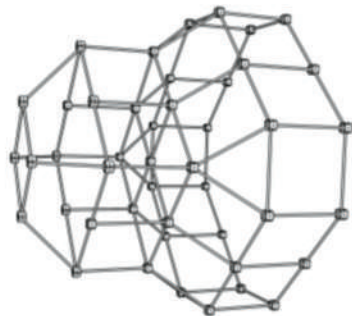

DAS ABENTEUER GEHT NOCH WEITER

Entdecken Sie kreative Ideen auf unserer Website, indem Sie diesen QR-Code scannen:



Und teilen Sie Ihre Kreationen in den Netzwerken unter dem Hashtag #1001hütten.

Bei Problemen oder Fragen zu den Produkten können Sie sich gerne über das Kontaktformular auf unserer Website www.sarbakane.com oder per E-Mail an contact@sarbakane.fr an uns wenden.

Folgen Sie uns auf sozialen Netzwerken:



@sarbakane_toys



SarbakaneToysFR





DESSINE ICI TA CABANE



DRAW YOUR DREAM HUT HERE

GESTALTE HIER DEINE HÜTTE



